



Safety and reliability improvements in OSIRIS

C. BLOCQUEL

Nuclear Energy Direction
Department of Reactors and Nuclear Services

CEA/SACLAY, 91191 Gif-sur-Yvette cedex, FRANCE



CEA Saclay – Main nuclear facilities



INB 50
LECI
(hot cells)

INB 72
Solid waste
facility

INB 48
SATURNE
(dismantled)

INB 77
POSEIDON
(irradiators)

INB 43
ALS
(dismantled)

INB 40
OSIRIS
(70 MW reactor)

INB 101
ORPHEE
(14 MW reactor)

INB 29
CIS-BIO
(isotopes for
medicine)

INB 49 – LHA
(dismantling)

INB 18
ULYSSE
(training reactor
dismantling)

INB 35
Liquid waste
facility



THE EXPERIMENTAL PLATFORM

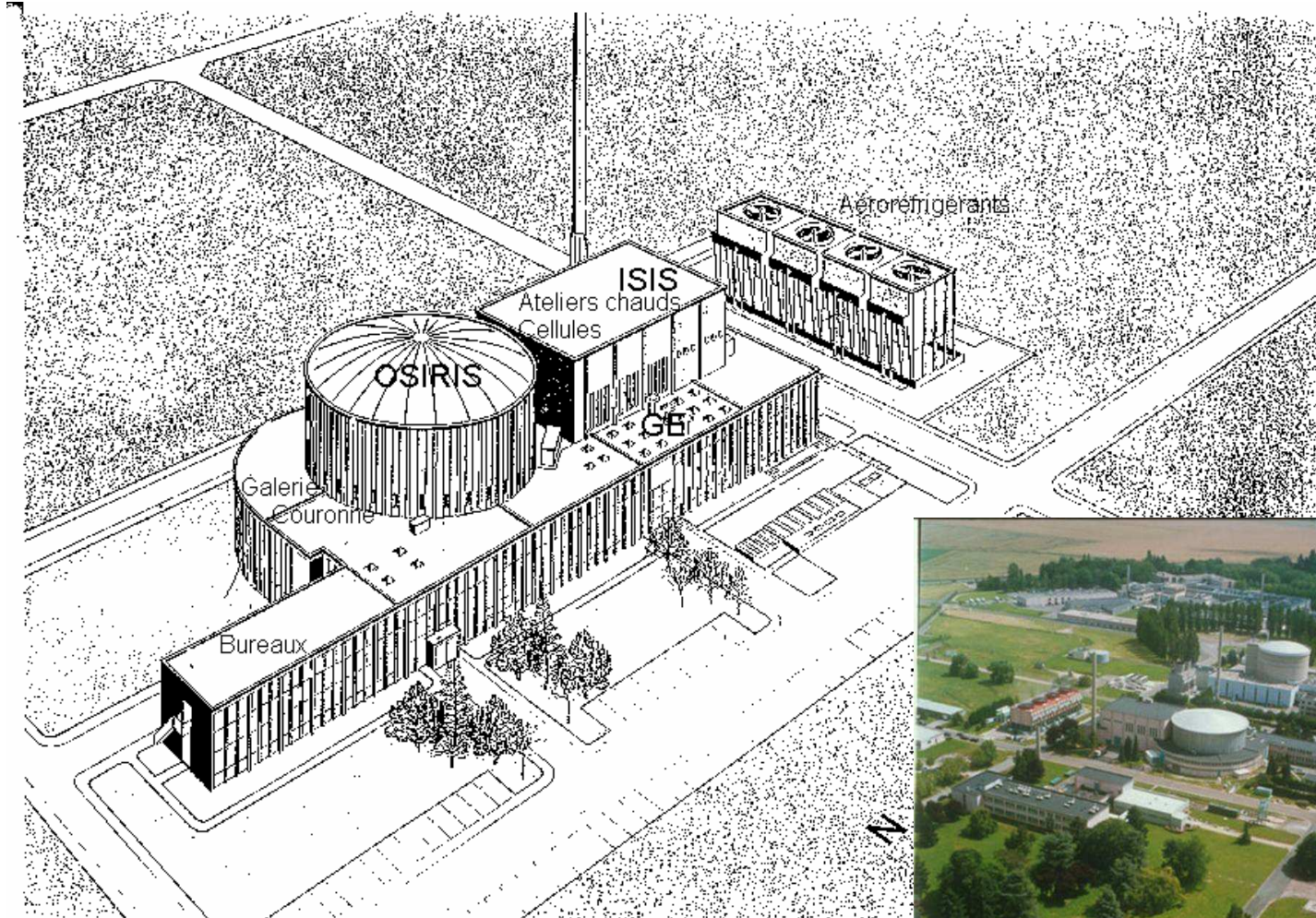

MAIN EVENTS



- ❖ Start of construction end of 1963
- ❖ Installation authorised 08/06/1965
- ❖ First divergence ISIS 28/04/1966
- ❖ First divergence OSIRIS 08/09/1966
- ❖ First cycle OSIRIS 08/09/1966
- ❖ Power 50 MW 07/10/1966
- ❖ Power 70 MW 11/12/1968
- ❖ New core Caramel 25/07/1979
- ❖ Conversion to Silicide fuel OSIRIS 1996
- ❖ Silicide core in ISIS Nov 1998
- ❖ Safety reassessment Nov 1999



VERTICAL SIGHT

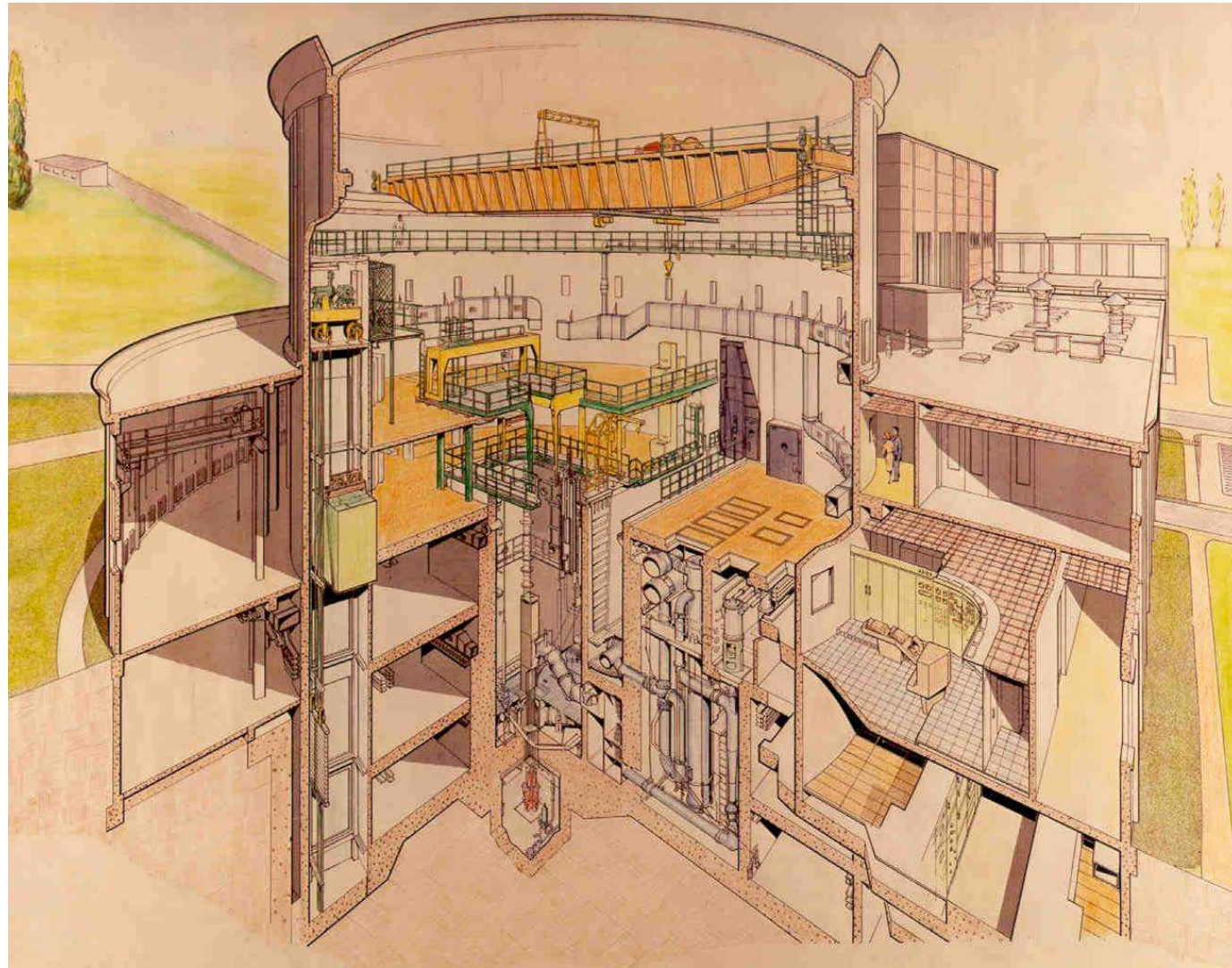

OSIRIS – MAIN UPGRADING OPERATIONS



Safety function : Reactivity

1992-93 Replacement of instrumentation and control - Centralized data processing finished in 93

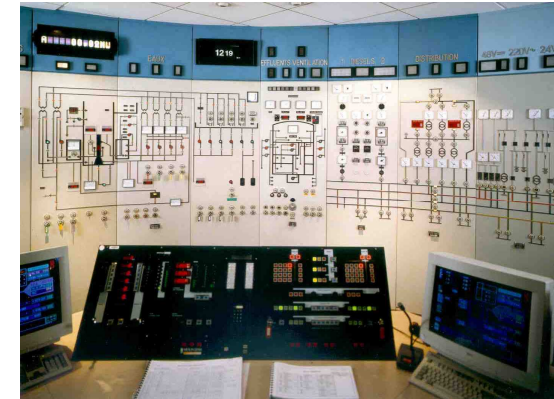

1996-97 Replacement of fuel housing (and conversion Caramel to Silicide)



2005 Upgrading emergency panel

2004-06 Replacement of instrumentation and control of Isis



OSIRIS – MAIN UPGRADING OPERATIONS

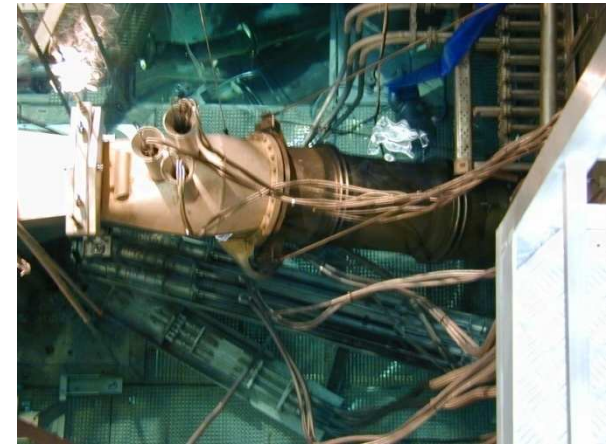
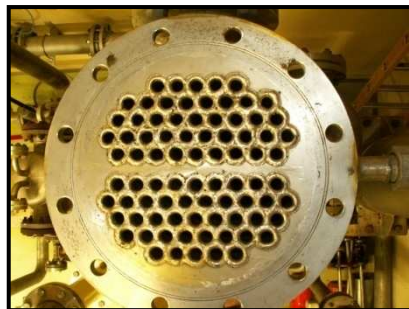

Safety function : Cooling

- 1993 Partial replacement of primary admission pipe
- 1996-97 Replacement of cellular core structure
- Visual inspection of primary circuit and pool
- 2003 & 2006 Non destructive controls on primary core circuit
- 2006 Osiris exchangers controls
- Setting an emergency pool-filling circuit
- 2008 Isis exchangers control



OSIRIS – MAIN UPGRADING OPERATIONS



Safety function : Containment

1988-89 Doing up of the liquid waste storage tanks

1994-95 Doing up of decay tanks on primary core and pool circuits

1999-2000 Doing up the 1, 2 & 3 channels

2001-02 Replacement of core tank
Double containment on liquid waste storage tanks

Liner on channel n°3

2000-03 Upgrading static confinement

2004 Decay tanks inspection

2006 Loads bridling device in channel 2

2007 Decay tanks inspection

2009 Core decay tank casing repair

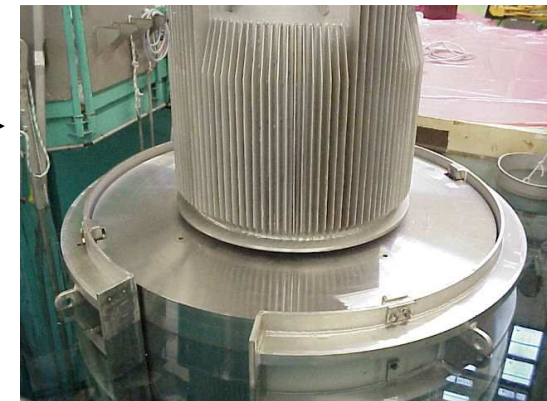
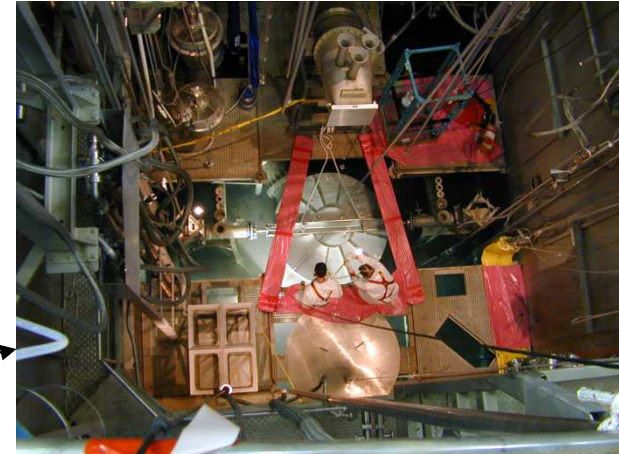

STATIC CONTAINMENT UPGRADING OPERATIONS



1977 Isis pool refurbishment

2001 Containment fissures repairs

2003 Batches containment upgrading

Registers and valves on ventilation circuit

2003-06 Regulation ventilation valves

2006 Extension of channel door

2005-07 Gaseous effluents room containment

2008 Replacement of a containment
ing
ing and cleaning hot cell



OSIRIS – MAIN UPGRADING OPERATIONS



Safety function : Radioprotection

- 1983** **Radiation Protection Control Panel**
- 2000 & 2005** **Refurbishment of survey devices
of secondary circuit activity**
- 2004-06** **Replacement of information
treatment units**
- 2008** **Setting of flow-meters inside
ventilation exhaust chimney**



OSIRIS – MAIN UPGRADING OPERATIONS



Support functions

1988-1989 Complete revision of emergency power units

1990 Replacement of 48 V supply network

Replacement of low voltage switchboards

1999-2000 Requalification of emergency power units

2000 Replacement of rectifiers and wavers

2005-07 Heavy maintenance of diesel engines and alternators

2004-08 Replacement of HV/LV Transformers

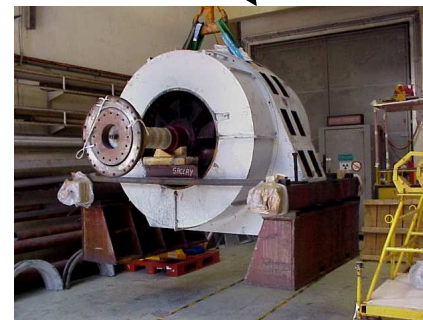

SAFETY IMPROVEMENT 2008 - 2010

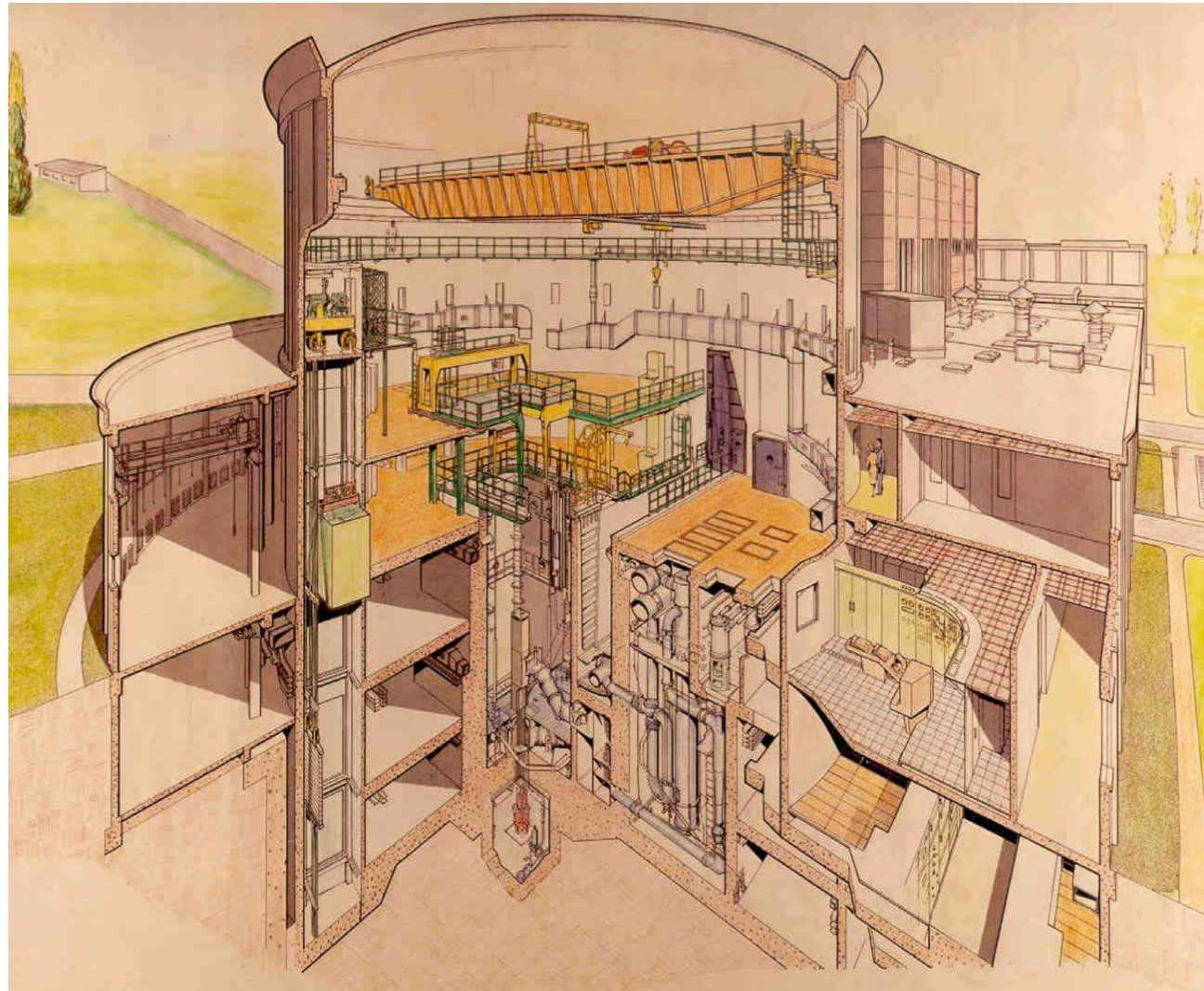

Hoistering improvement



Fiability improvement of lifting means (hot workshop crane – Osiris crane – Isis crane – other hoists)

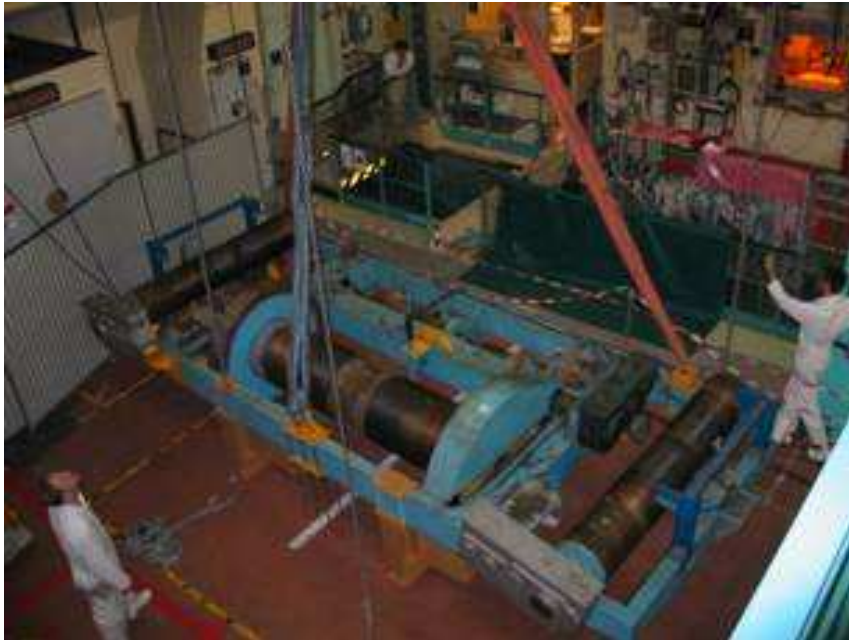

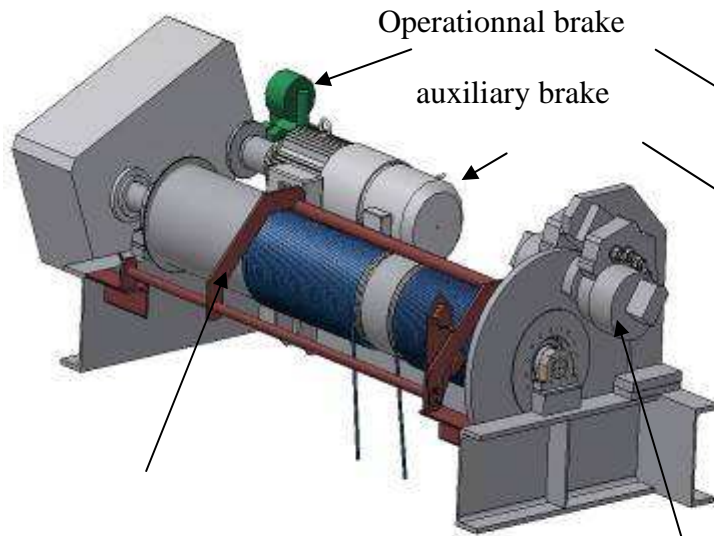

- Redundancy wire ropes, three brakes
- Safety power supply circuits act independently from operating control circuit
- Vertical and lateral movements interlocked
- Speed control

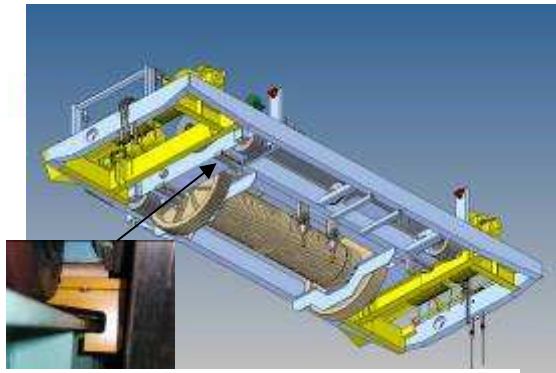

Trolley anti-derailment



Safety brake on rope drums

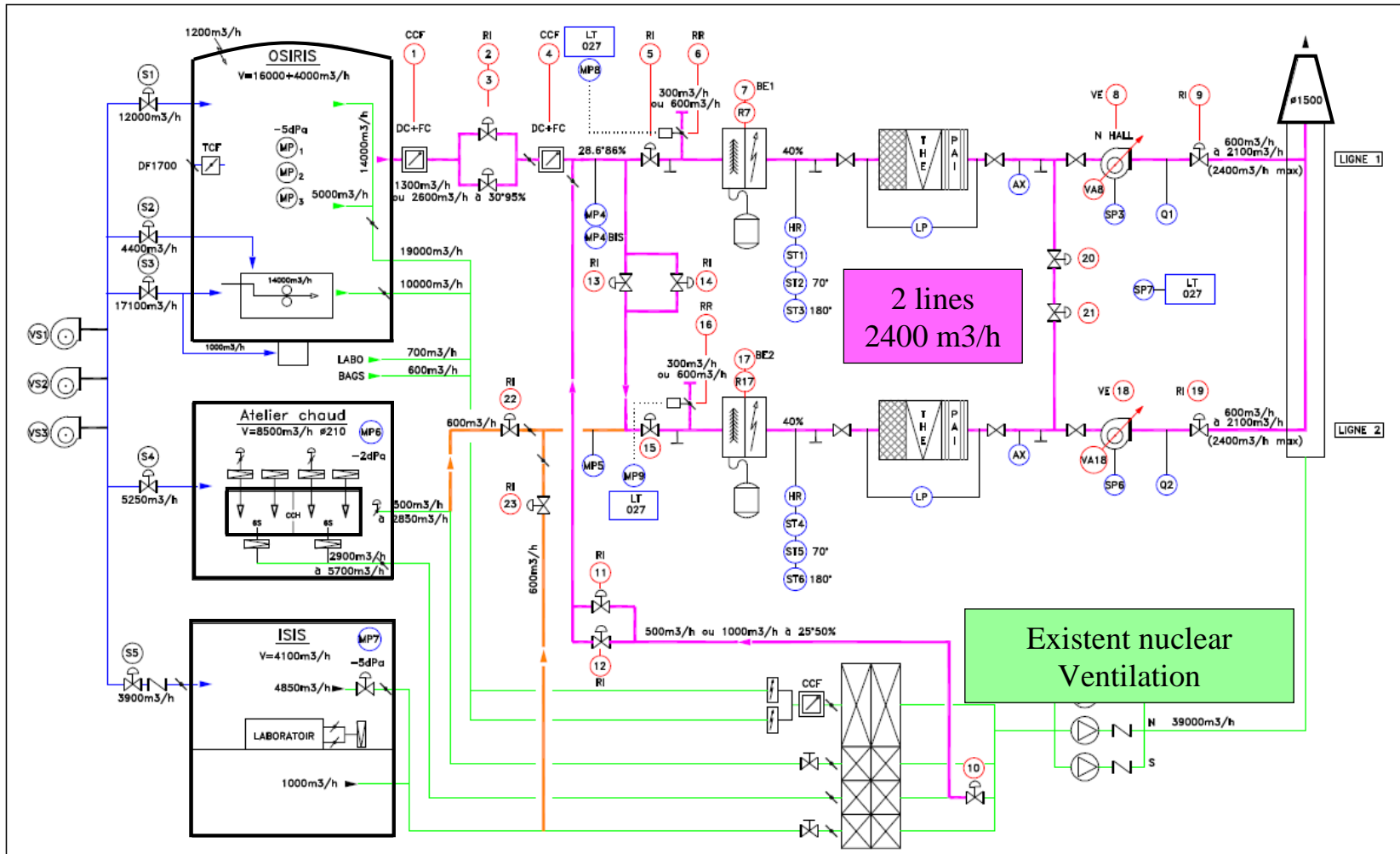

Self-actuated for OSIRIS and hot cell
Manual operation for ISIS and hot workshop

Emergency powering
Operation from Main control room
and Emergency control panel



Post-accident ventilation

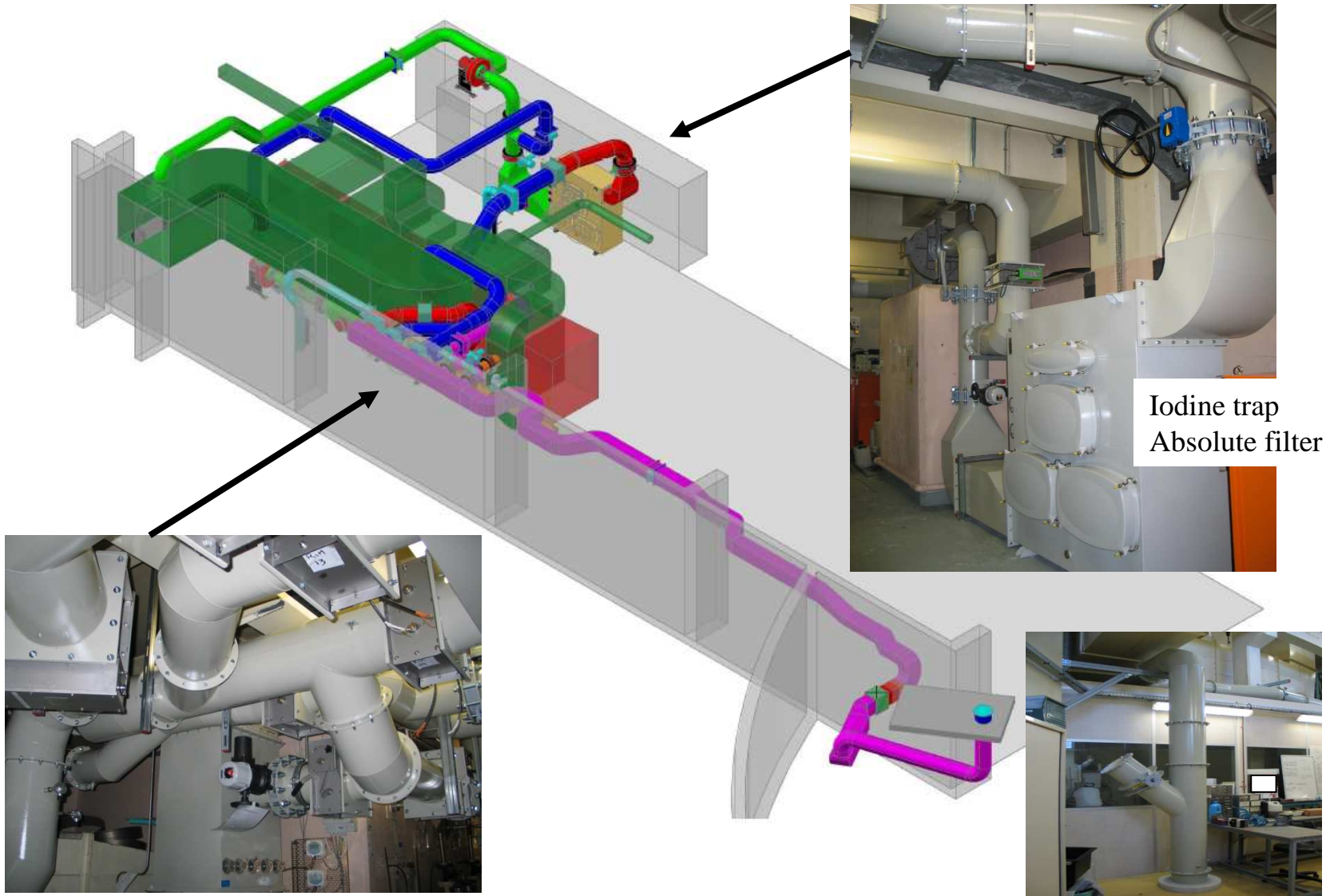

Trucks' hatch



In order to give an extension of the containment during loading and unloading phases

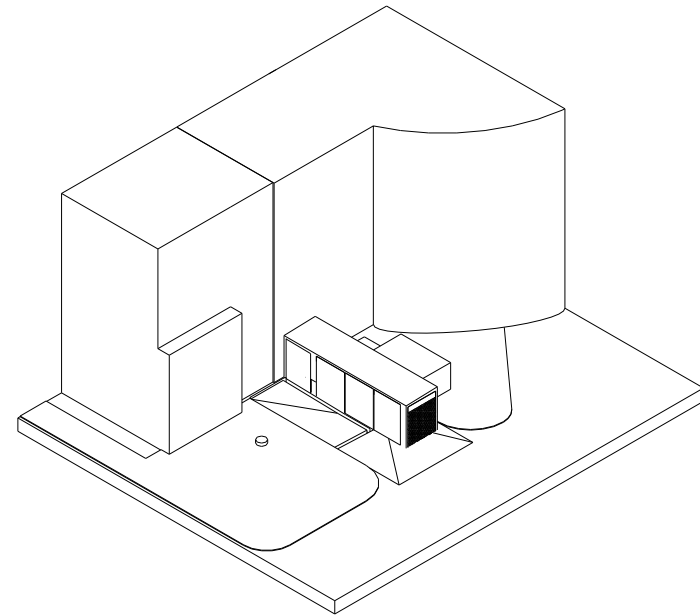

Control rods mechanisms room's containment



Upgrade the tightness of the room in order to reduce radioactive liquid transfers to the environment

**Heavy operation
(5 months)**



Limit the pool level's going down



In case of a leak towards control rods mechanisms room or a BORAX accident, limit the pool level's going down and avoid overflows in the plant

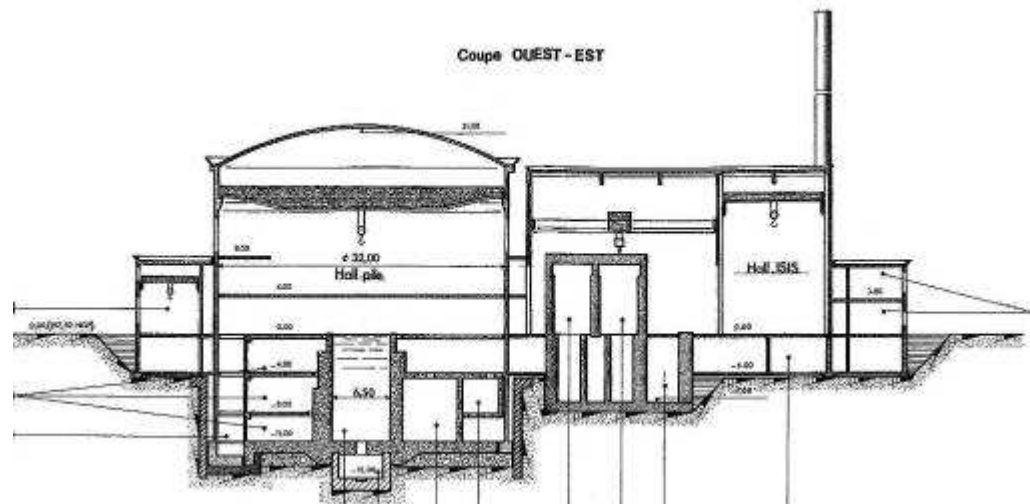
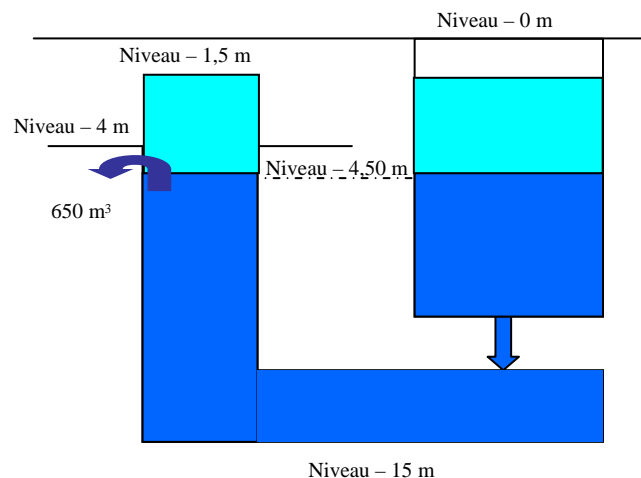

Increase the tightness and strength of the structures



Walling up PANES and SIDE-LIGHTS
on Isis and hot workshop structures



Increase the tightness and strength of the structures

cea

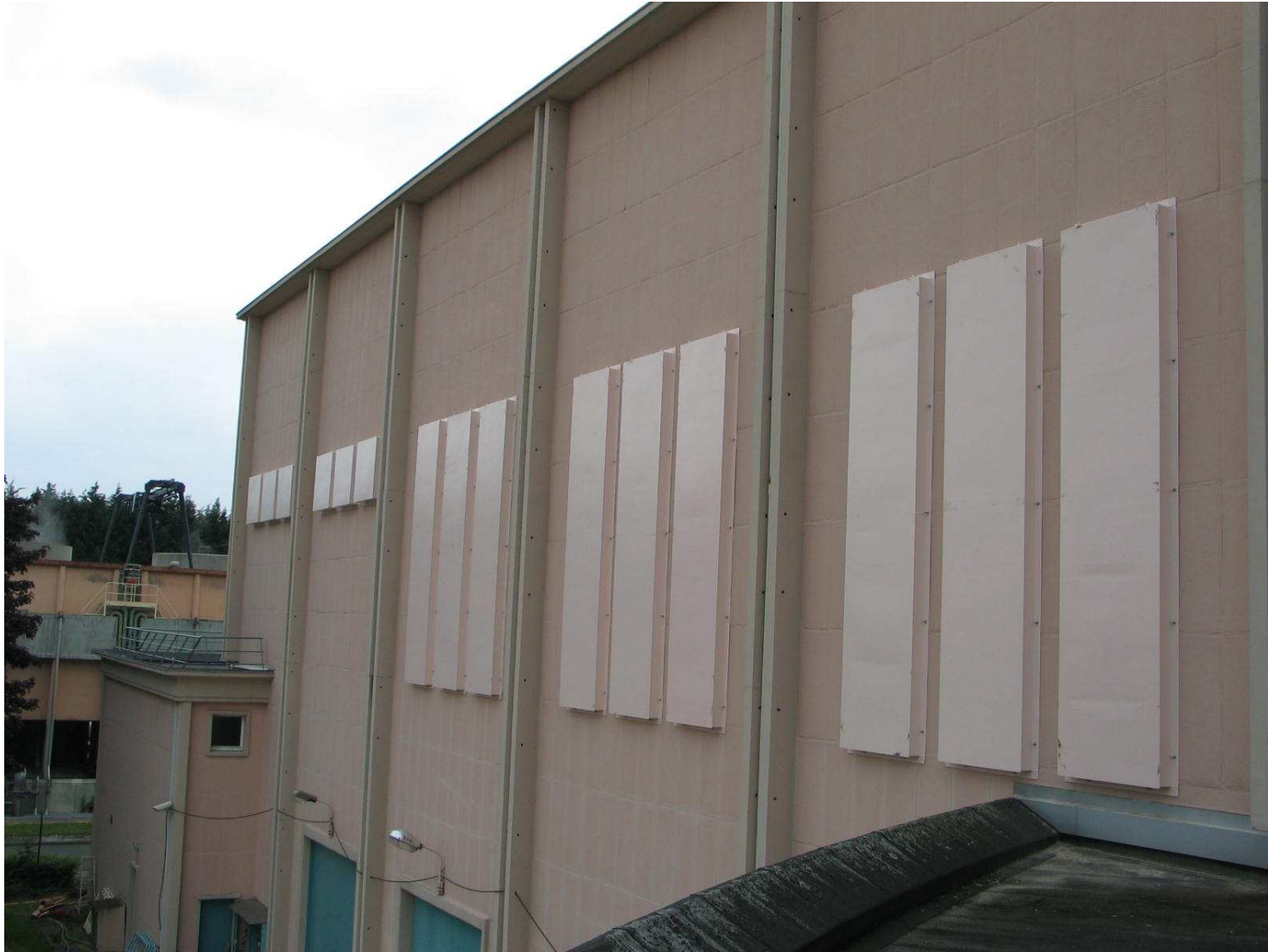

Automatic shutdown in case of external hazards



After detection of

- ✓ Earthquake
- ✓ Outside explosion

Equivalent system to dome accelerometers detecting plane's fall

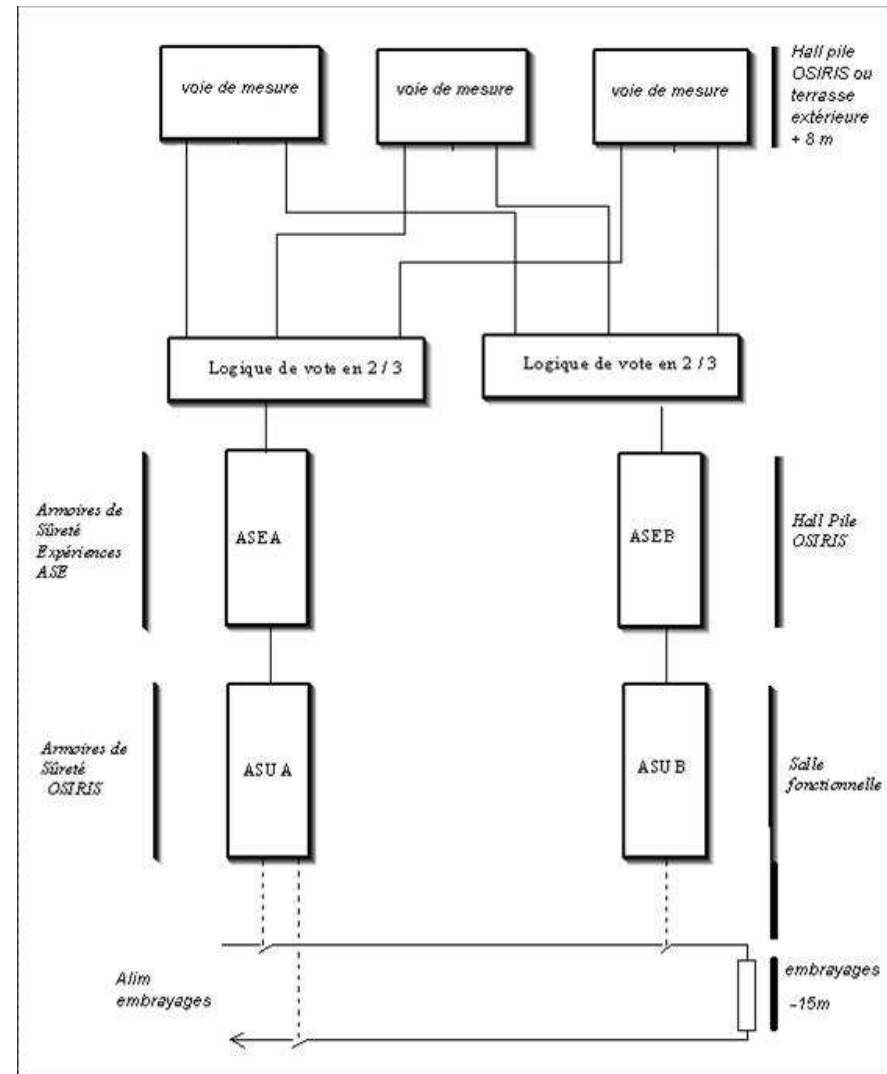

Forecast schedule

