

## **FEASIBILITY STUDIES FOR SIMULTANEOUS IRRADIATION OF NBSR & MITR FUEL ELEMENTS IN THE BR2 REACTOR**

**Silva Kalcheva, Steven Van Dyck, Sven Van den Berghe, Geert Van den Branden**

SCK.CEN, BR2 Reactor  
Boeretang, 2400 Mol –Belgium

[skaltche@sckcen.be](mailto:skaltche@sckcen.be), [svdyck@sckcen.be](mailto:svdyck@sckcen.be), [svdbergh@sckcen.be](mailto:svdbergh@sckcen.be), [gvdbrand@sckcen.be](mailto:gvdbrand@sckcen.be)

### **ABSTRACT**

The BR2 reactor is involved in preliminary neutronics feasibility studies for irradiation of four Design Demonstration Element (DDE) tests foreseen in the US High Performance Research Reactor (USHPRR) conversion program: MURR, MITR, NBSR and HFIR. The purpose of the irradiation will be to qualify the new LEU fuel material for each DDE Lead Test Assembly in the BR2 reactor at conditions that are similar for the reactor of origin. The present paper focuses on the preliminary feasibility scenarios for simultaneous irradiation of two DDE's: the MITR and the NBSR Lead Test Assemblies in the BR2 reactor. The MITR and the NBSR fuel elements will be loaded in the 200 mm diameter channels (H5 and H3). In order to 'mimic' the irradiation conditions for each DDE in the BR2 reactor as in the original reactors, a number of optimization scenarios are considered. The flux and burn-up calculations are performed using the fully automatic option of the MCNP6/CINDER90 code.

KEYWORDS: LEU, conversion, MITR, NBSR, MCNP6

### **1. INTRODUCTION**

The BR2 reactor along with other MTR reactors (ATR) is involved in preliminary neutronics feasibility studies for irradiation of four Design Demonstration Element (DDE) tests foreseen in the US High Performance Research Reactor (USHPRR) conversion program: the Missouri University Research Reactor (MURR), the Massachusetts Institute of Technology Reactor (MITR), the National Bureau of Standards Reactor (NBSR) and the High Flux Isotope Reactor (HFIR). The purpose of the irradiation will be to qualify the new LEU fuel material for each DDE Lead Test Assembly in the BR2 reactor at conditions that are similar for the reactor of origin, respectively at the conditions of MURR, MITR, NBSR, HFIR. The first important studies for the feasibility irradiations of all DDE's are the neutronics studies of power and burn-up profile evolution, which are the basis for further thermo-hydraulics analyses.

The present paper is focused on the preliminary feasibility scenarios for simultaneous irradiation of two DDE's: the MITR and the NBSR Lead Test Assemblies in the BR2 reactor. The BR2 reactor has a long history examination LTA's of a different reactor, such as the Jules Horowitz Reactor Fuel Elements, which have been successfully tested during 5 years irradiation campaign. The BR2 reactor also has a high flexibility to operate with a small compact core (20-25 fuel elements) up to extended one (30-35 fuel elements) with a flexibility to locate the control rods in different channels.

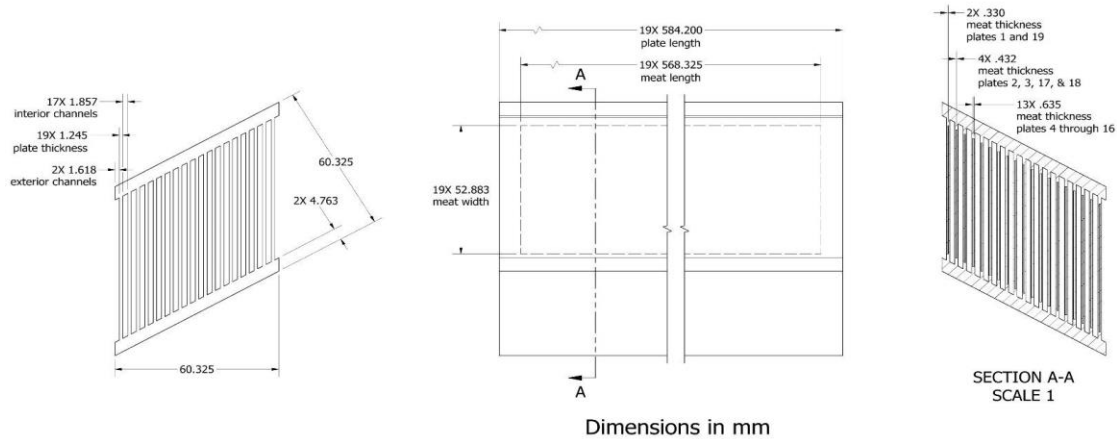
In the present paper, the MITR and the NBSR fuel elements are loaded in the 200 mm diameter channels, in the channel H5 and H3 of the BR2 reactor, respectively. The requests for the maximum surface heat fluxes and fission density in the peak regions of the DDE-MITR and DDE-NBSR differ significantly: 64 W/cm<sup>2</sup> maximum heat flux in the hot spot of DDE-MITR at BOL vs. 160 W/cm<sup>2</sup> in the hot spot of DDE-NBSR at BOL. In order to ‘mimic’ the irradiation conditions for each DDE in the BR2 reactor as in the original reactors, a number of optimization scenarios are considered: (i) optimization of the axial positions of both DDE’s in the chosen channels; (ii) modification of the DDE-NBSR axial dimensions; (iii) azimuth orientation of the DDE-MITR; (iv) optimization of the content in the surroundings channels; (v) loading of baskets with absorber material around DDE-MITR; (vi) choice of material for the irradiation baskets. Detailed 3-D power and burn-up time evolution profiles are evaluated with MCNP6.

## 2. TECHNICAL REQUIREMENTS FOR DDE’s

The purpose is to perform predictive modeling and scoping evaluations for full size LEU fuel test assembly for each DDE in order to demonstrate the feasibility for achieving the target irradiation conditions (power, heat flux and burn-up) in the BR2 reactor. The concurrent irradiation of both DDE’s would be eligible.

### 2.1. DDE-MITR

The DDE-MITR irradiation campaign shall irradiate full size MITR fuel assembly. Non-fueled aluminum extensions do not needed to be modeled in details. The geometry models of the DDE-MITR fuel assembly are given in Figure 1. The fuel meat of each plate should be modeled with uniform mesh regions having 4 in the transverse direction (13.2 mm wide) and 18 in the axial direction (31.6 mm long).



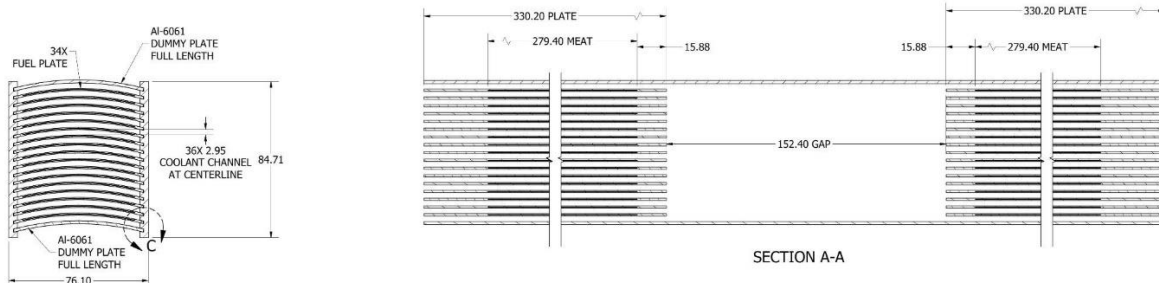
**Figure 1.** DDE-MITR geometry & dimensions.

The peak regions on each plate, for both beginning of life (BOL) power and End of Life (EOL) burnup, should occur along a transverse edge in approximately the bottom half of the assembly. If possible, the axial power profile of the fuel assembly should be tilted to exhibit lower power in the top regions than the bottom. It is not crucial to match exact power profiles, but approximate distributions are desirable in order to better represent MITR conditions. The requested target irradiation conditions are as follows: maximum heat flux,  $Q_{\max}=64$  W/cm<sup>2</sup> and maximum fission density,  $F_{\max}=5.8E21$  fissions/cm<sup>3</sup>.

### 2.2. DDE-NBSR

The DDE-NBSR irradiation campaign shall irradiate a full size NBSR fuel assembly (non-fueled aluminum hardware regions may be shortened based on dimensional constraints). The DDE-NBSR geometry &

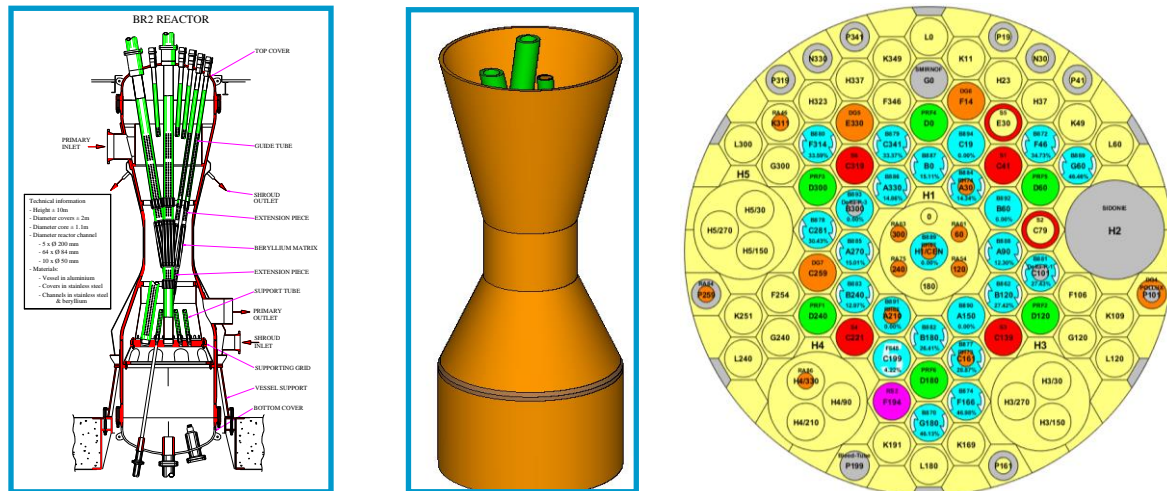
dimensions are shown in Figure 2. The fuel meat of each plate should be modeled with uniform mesh regions having 3 azimuthal zones (~20 mm wide) and 14 axial zones (~20 mm long). The requested target irradiation conditions are as follows: maximum heat flux,  $Q_{\max}=160 \text{ W/cm}^2$  and almost 100%  $^{235}\text{U}$  burn-up.



**Figure 2.** DDE-NBSR geometry & dimensions.

### 3. DESCRIPTION OF THE BR2 REACTOR AND CORE LOAD

The Belgian Material Test reactor (MTR) BR2 is a strongly heterogeneous high flux engineering test reactor operated by SCK•CEN at the Mol site in Belgium. This tank-in-pool reactor is cooled by light water in a compact HEU core (93%  $^{235}\text{U}$ ), positioned in and reflected by a beryllium matrix (see Fig. 1).



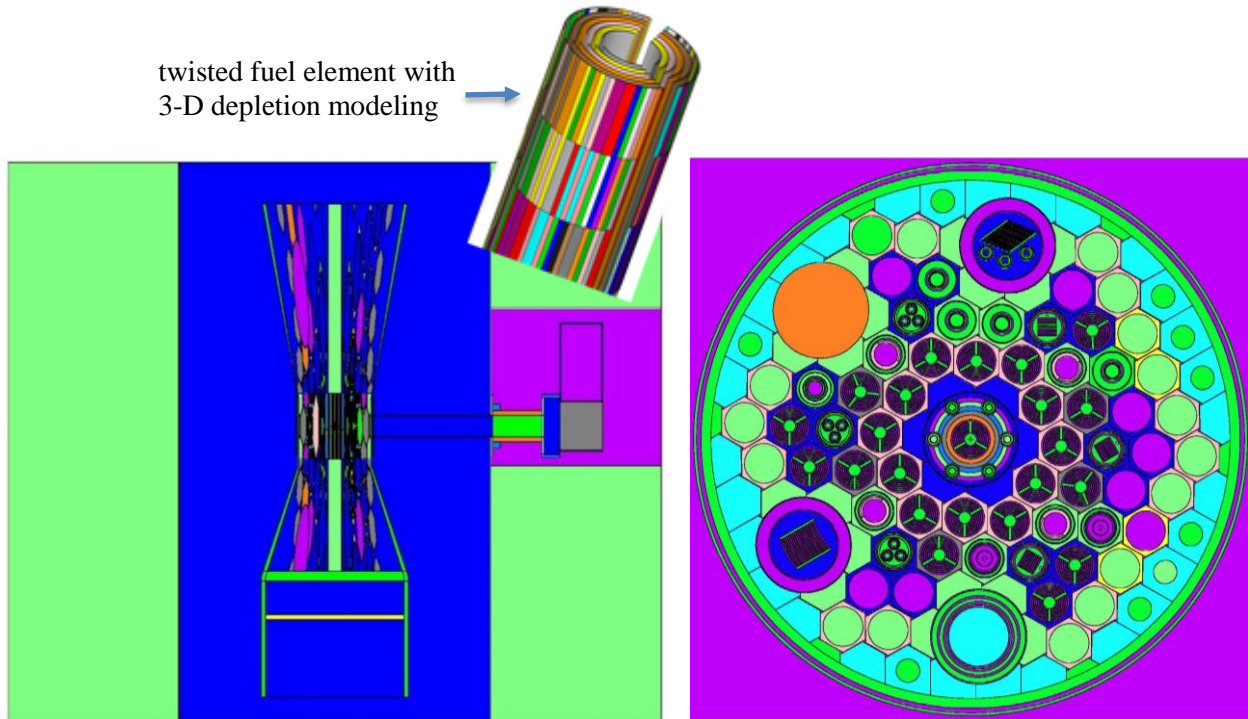
**Figure 3.** The BR2 reactor (left), 3-D MCNP/SABRINA model (center), loading map for the cycle 03/2017A.3 used for the calculation of DDE's (right: blue color – fuel elements, red color – control rods, green & grey – irradiation experiments, yellow – beryllium matrix).

The beryllium matrix is an assembly of a big number of irregular hexagonal prisms which are skew and form a twisted hyperbolic bundle around the central 200 mm channel H1 containing beryllium plugs. The reactor can be operated at the power level of 50÷100 MW, currently about 130 to 150 full power days per year with thermal neutron flux  $1.2 \times 10^{15} \text{ cm}^{-2} \cdot \text{s}^{-1}$  and fast neutron flux  $1.0 \times 10^{15} \text{ cm}^{-2} \cdot \text{s}^{-1}$  at power 60 MW. The BR2 core load used in the calculations for the feasibility of the irradiation tests is similar to the load of the cycle 03/2017A.3. The loading of the reactor core channels is given in Figure 3 (right).

## 4. REACTOR CORE & DDE MCNP MODELING

### 4.1. Full Core 3-D Geometry Model of the BR2 Reactor

A 3-D geometry and burn-up model of the BR2 core is developed by the SCK•CEN team using the latest versions of the Monte Carlo transport code MCNP6 [1]. The model is a complete 3-D description of BR2's one sheet hyperboloid reactor core composed of twisted and inclined reactor channels and represents each channel separately, with its individual position and inclination (see Figure 4 – left). The fuel assemblies, beryllium plugs, experimental devices or control rods loaded in the channels are modeled with the same level of details. The fuel region of each of the 6 fuel rings of every fuel element is axially divided into 10 material cells of 6 cm height and 2 extreme cells of 8.1 cm height, and into 72 azimuth meshes in needed axial segments. The MCNP model of the BR2 reactor core load for a cycle similar to the load of the cycle 03/2017A.3 is given in Figure 4 – right. The BR2 reactor core consists of two types of reactor beryllium hexagonal channels: 79 with diameter 84 mm and 5 channels with diameter 200 mm. Due to their dimensions, the DDE-MITR-FE and the DDE-NBSR-FE can be loaded only in 2 of the 200 mm diameter channels.



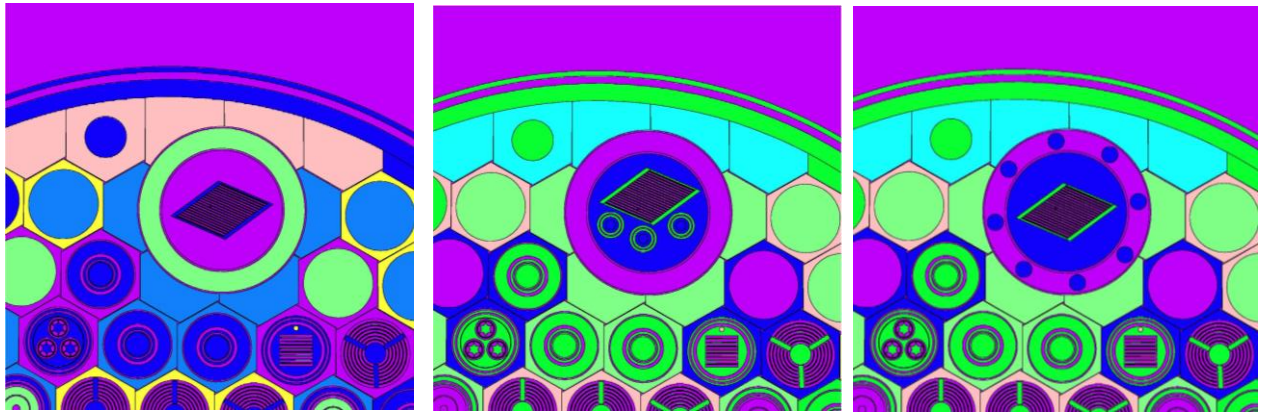
**Figure 4.** MCNP model of the BR2 reactor including the vessel and the bio-shield with embedded in model of inclined fuel element (left). MCNP model of BR2 core load similar to the load of cycle 03/2017A.3 with DDE-MITR-FE in channel H5 and DDE-NBSR-FE in channel H3 (right).

### 4.2. MCNP Model of DDE-MITR-FE

#### 4.2.1. Choice of location channel and modeling optimizations

The simultaneous irradiation of the DDE-MITR-FE and the DDE-NBSR-FE presents a challenge for the core load management in order to find a compromise solution for satisfying two opposite target irradiation conditions, such as very low maximum heat flux ( $Q_{\max} \sim 64 \text{ W/cm}^2$  in DDE-MITR-FE) and almost 3 times higher maximum heat flux ( $Q_{\max} \sim 160 \text{ W/cm}^2$  in DDE-NBSR-FE).

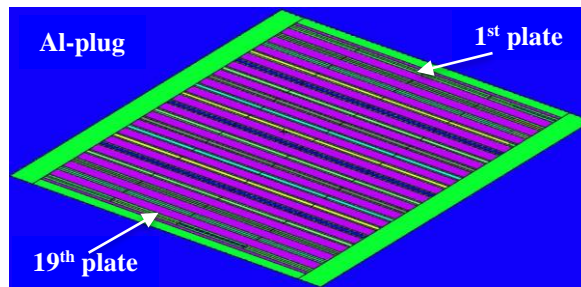
The DDE-MITR-FE is loaded in the channel H5 of the BR2 reactor core (see Figure 4 – right and Figure 5). The geometry model and dimensions are the same as described in the Section 2.1. In order to ‘mimic’ the original target irradiation conditions and to satisfy the requested irradiation targets, a number of optimizations are considered: (i) the orientation of the DDE-MITR-FE is as shown in Figure 5; (ii) special loading in the surrounding channels include loading of 3 DG devices for isotope production, which contain absorbing materials (aluminum, light water, etc.); (iii) appropriate choice of material for the inner and outer plug (aluminum for the inner plug and beryllium for the outer plug); (iv) additional RA-baskets filled with absorbing materials (cobalt, tungsten or iridium) are located in the inner Al-plug and/or in the outer Be-plug, which after irradiation can be used for a variety of reactor experiments (e.g., cobalt as gamma source, tungsten for testing of fusion materials, iridium for use in medicine and industry, etc.). Three typical models of the DDE-MITR-FE have been developed and tested as follows: (i) a model without absorbing rods in the inner or outer plug as shown in Figure 5 – left; (ii) a model with 3 absorbing rods (Co or W) in the inner Al-plug, in this model the diameter of the absorbing rods is varied between  $D=12$  mm to  $D=25$  mm (see Figure 5 – center); (iii) a model with absorbing rods in the outer Be-plug as shown in Figure 5 – right.



**Figure 5.** MCNP model of DDE-MITR in H5-channel: *without absorbing rods (left); with absorbing rods in the inner Al-plug (center); with absorbing rods in the outer Be-plug (right).*

#### 4.2.2. MCNP calculation model of DDE-MITR-FE

The MCNP model of the DDE-MITR-FE contain 19 plates with parameters as described in Figure 1, and in Table I. Each fuel plate is modeled with uniform mesh, having 4 in the transverse direction (13.2 mm wide) and 18 in the axial direction (31.6 mm long). A cross section of the MCNP model of the DDE-MITR-FE is shown in Figure 6.



**Figure 6.** Cross section of the MCNP model of DDE-MITR-FE containing 4 uniform mesh transverse regions, each 13.2 mm wide.

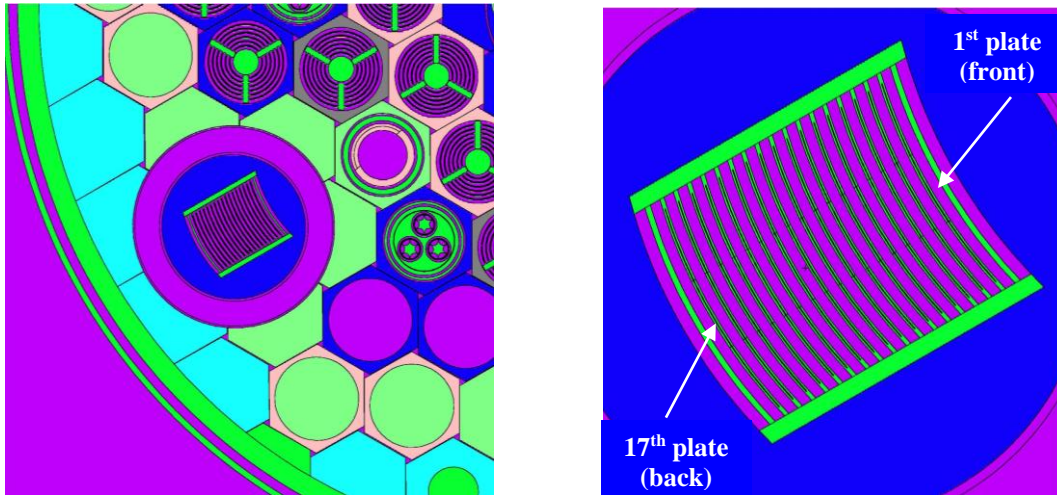
**Table I.** Summary of DDE-MITR-FE parameters in H5 channel.

Axial position in H5 channel relatively to reactor core mid-plane, mm	+123.8
Outer/inner radius of outer fresh Be-plug, mm	99.8/75.0
Radius of inner Al-plug, mm	72.50
$U_{total}$ density, g/cm <sup>3</sup>	15.3
U10Mo density, g/cm <sup>3</sup>	17.0
<sup>235</sup> U enrichment, %	19.75
<sup>236</sup> U enrichment, %	0.24
Meat thickness of fuel plates 1 & 19, mm	0.33
Meat thickness of fuel plates 2, 3,17 & 18, mm	0.432
Meat thickness of fuel plates 4 to 16, mm	0.635
Plate thickness, mm	1.245
2 exterior water channels thickness, mm	1.618
Plate length, mm	584.200
Meat length, mm	568.325
Diameter of 3 cobalt/tungsten, absorber rods in inner Al-plug, mm	12 or 20 or 24
Diameter of 6 cobalt/tungsten, absorber rods in outer Be-plug, mm	20 – 23

### 4.3. MCNP Model of DDE-NBSR-FE

#### 4.3.1. Choice of location channel and modeling optimizations

The DDE-NBSR-FE is loaded in the channel H3 of the BR2 reactor core (see Figure 4 – right and Figure 7). The geometry model and dimensions are the same as described in the Section 2.2. The mid-plane of the DDE-MITR-FE is located at  $Z=+10.0$  cm relatively to the reactor mid-plane: the lower plate is located between  $Z=-25.64$  cm to  $Z=+7.38$  cm, and the upper plate is located between  $Z=+12.62$  cm to  $Z=+45.64$  cm.



**Figure 7.** MCNP model of DDE-NBSR –FE in H3-channel (left). Cross section of the MCNP model of DDE-NBSR-FE containing 3 uniform mesh azimuthal regions, each 20 mm wide (right).

In order to ‘mimic’ as much as possible the original target irradiation conditions and to satisfy the requested irradiation targets, a few optimizations are considered: (i) the orientation of the DDE-NBSR-FE as shown in Figure 4 – right and Figure 7; (ii) the DDE-NBSR-FE is positioned in the center of the channel H3; (iii) 60% Al + 40% Be used for the inner basket and 100% Be for the outer basket; (iv) the axial length of the water gap has been reduced from 15.24 cm to 5.24 cm.

#### 4.3.2. MCNP calculation model of DDE-NBSR-FE

The MCNP model of the DDE-NBSR-FE contain 17 fuel plates in the upper plate and 17 fuel plates in the lower plate with parameters as described in Figure 2 and in Table II. Each fuel plate is modeled with uniform mesh, having 3 azimuthal zones (20 mm wide) and 14 axial zones (20 mm long). A cross section of the MCNP model of the DDE-NBSR-FE is shown in Figure 7 – right.

**Table IV.** Summary of DDE-NBSR-FE parameters in H3 channel.

Axial position in H3 channel relatively to reactor core mid-plane, mm	+100.0
Outer/inner radius of outer fresh Be-plug, mm	99.8/75.0
Radius of inner 60%Al+40%Be-plug, mm	72.50
$U_{\text{total}}$ density, g/cm <sup>3</sup>	15.3
U10Mo density, g/cm <sup>3</sup>	17.0
<sup>235</sup> U enrichment, %	19.75
<sup>236</sup> U enrichment, %	0.24
Meat thickness of all (17 lower + 17 upper) fuel plates, mm	0.22
Plate thickness, mm	1.27
36 water channels thickness, mm	2.95
2 dummy exterior plates thickness, mm	1.65
Meat length (upper, lower plate), mm	279.4
Plate length (upper, lower plate), mm	330.2
Water gap between lower and upper plates, mm	52.4

## 5. BR2 FULL REACTOR CORE & DDE EVOLUTION SIMULATION

### 5.1. MCNP Calculation Methodology

#### 5.1.1. Full reactor core evolution simulation

The MCNP6 simulation is coupled for the evolution part with CINDER90, which is included in the code. The preferred approach for the whole core automatic depletion calculations is to take advantage of the existing symmetries of the burned fuel material distribution in the core, i.e., the axial, radial and azimuth symmetries around the core center; In this case it is not necessary to give a unique material number to each burn-up cell. Cells having similar burn-up and power will experience the same composition evolution and can therefore be given the same material number. The MCNP model developed for this approach has a total of 2304 burn-up cells (12 axial zones x 6 fuel rings x 32 fuel elements + 16 beryllium matrix regions).

#### 5.1.2. DDE power and fuel burn-up evolution simulation

Calculation of the heat flux distributions in the different mesh regions of the DDE-MITR-FE are performed with tally F7:N using the steady-state option of the code MCNP6.

### 5.1.2.1. DDE-MITR-FE

The approach taken for the 3-D fuel burn-up and fuel density distributions is to model each fuel mesh with its own and unique fuel material number. Thus the total number of the fuel materials in the DDE-MITR-FE equals  $1368=19$  plates x 4 transverse regions x 18 axial zones. The calculations are performed for 26 consecutive typical BR2 operation cycles with duration 3 and 4 weeks, separated by shutdowns of about 30 days. Due to the very low value of the requested target heat flux  $Q_{\max} \sim 64$  W/cm<sup>2</sup> about 26 BR2 operation cycles are needed to reach the requested target fission density  $F_{\max} \sim 5.8$  fiss./cm<sup>3</sup>. The number of irradiation BR2 cycles can be reduced by two major ways. Firstly, if negotiate with MITR for eventual upgrade of the requested irradiation targets. For example, if the requested heat flux at BOL in the fresh DDE-MITR-FE will be 2 times higher ( $Q_{\max} = 130$  W/cm<sup>2</sup>), then the number of the irradiation cycles will be reduced twice (i.e., about 13 cycles) and the irradiation of the MITR-FE will take place during  $\sim 2,2$  years instead of  $\sim 4,3$  years. Another options are: (i) ‘play’ with the loading content of the surrounding reactor core channels; (ii) ‘load-in’, ‘load-out’ the absorbing rods in the inner Al-plug in the different cycles in order to maintain always the maximum heat flux in the burnt DDE-MITR-FE at the level of  $Q_{\max} = 64$  W/cm<sup>2</sup>.

### 5.1.2.2. DDE-NBSR-FE

The approach taken for the 3-D fuel burn-up and fuel density distributions in the lower and in the upper plate is to model each fuel mesh with its own and unique fuel material number. Thus the total number of the fuel materials in the DDE-NBSR-FE equals  $1428=(17$  plates x 3 azimuthal regions x 14 axial zones) upper plate + (17 plates x 3 azimuthal regions x 14 axial zones) lower plate. The calculations are performed for 26 consecutive typical BR2 operation cycles with duration 3 and 4 weeks, separated by shutdowns of about 30 days. The requested target heat flux values in the exterior plate are  $Q_{\max}=160$  W/cm<sup>2</sup> and  $Q_{\min}=139$  W/cm<sup>2</sup>.

## 5.2. Validation of MCNP Calculation Methodology

The credibility of the MCNP models were demonstrated by multiple comparisons of code predictions with available experimental data, such as control rod worth's, neutron fluxes, gamma heating, linear power and fission rates, reactivity effects, etc. (see Section V in [2] and Section IV in [3]).

## 6. CALCULATION RESULTS

### 6.1. DDE-MITR-FE

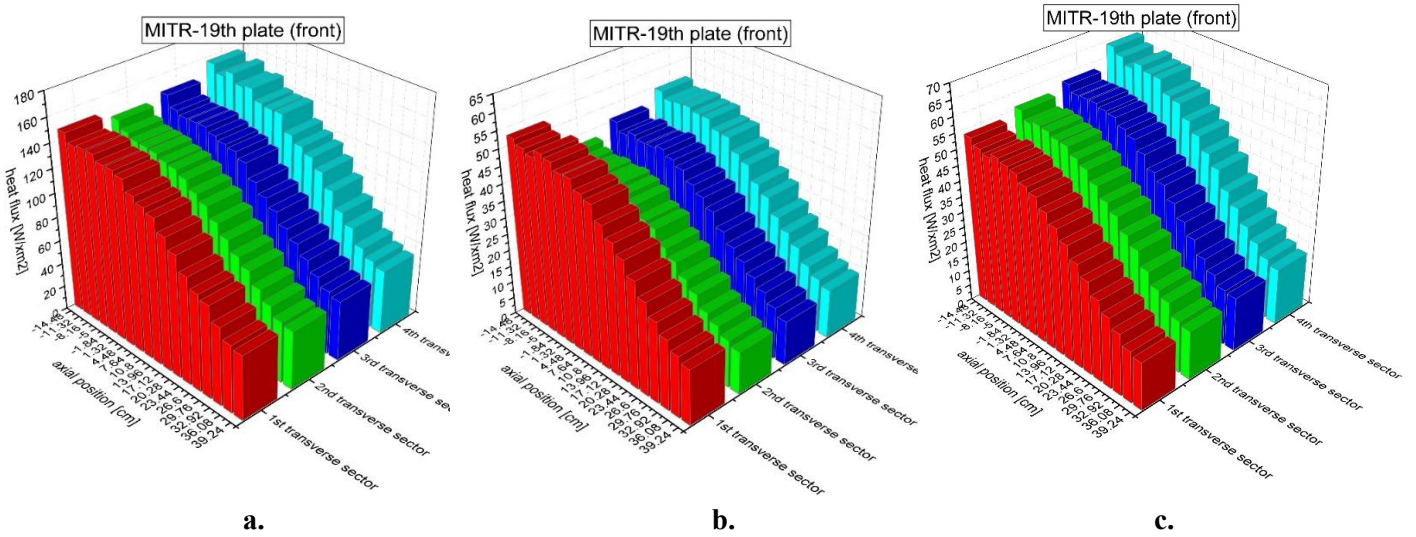
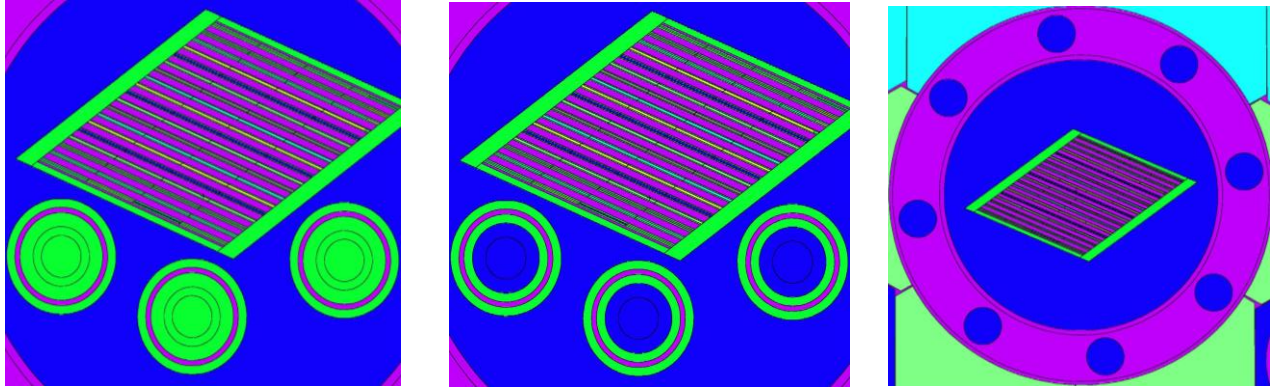
#### 6.1.1. Heat flux distributions in different optimization scenarios

The axial distributions of the heat flux at BOL in the four transverse regions of the exterior front plate and in the four transverse regions of the exterior back plate for different materials filling the RA-baskets in the inner Al-plug. Figure 8a refers to the case without absorbing rods, so the RA-baskets are filled with Al-rods. Figure 8b presents the scenario with absorbing rods (cobalt or tungsten) with diameter  $D=20$  mm. Additional scenario is considered with absorbing rods in the outer Be-plug as it is shown in Figure 8c.

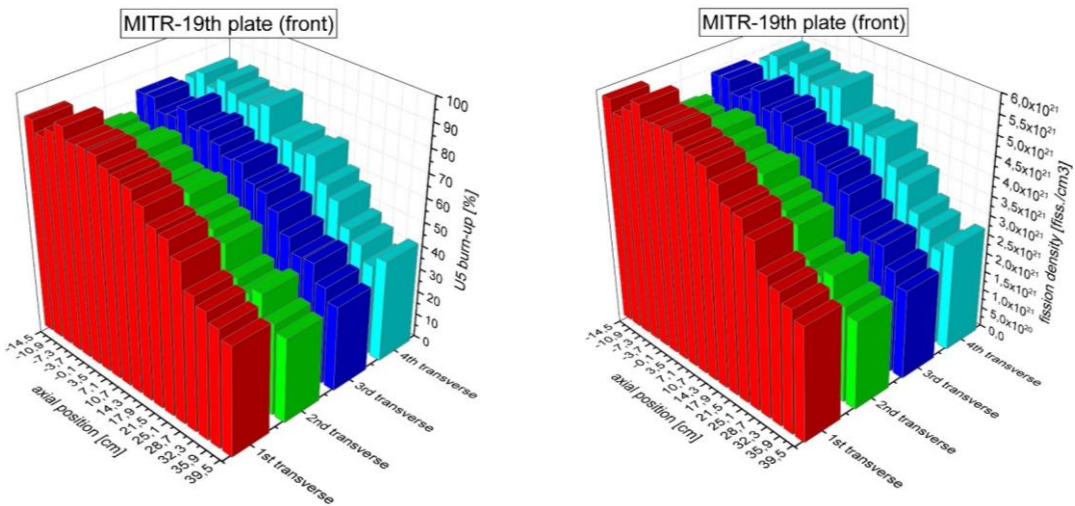
#### 6.1.2. Burn-up and fuel density distributions

Axial distributions of the <sup>235</sup>U burn-up (in %) and fission density (fiss./cm<sup>3</sup>) have been calculated in DDE-MITR-FE for the different scenarios. The calculations are performed using the automatic option of MCNP6, following 26 consecutive BR2 operation cycles. The distributions of the <sup>235</sup>U burn-up and fission density in the exterior plate for the scenario with cobalt rods are given in Figure 9. The time evolutions of the <sup>235</sup>U burn-up (in %) and fission density (fiss./cm<sup>3</sup>) in the hottest transverse region are given in Fig. 10.

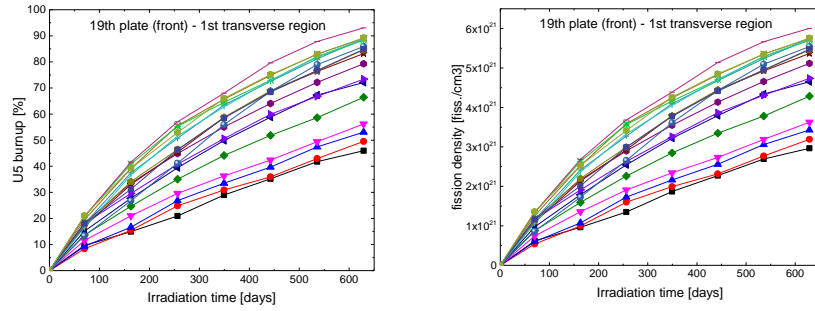




**Figure 8.** MCNP model of DDE-MITR-FE and heat flux distributions with three RA-baskets filled with Al-rods (left); b. with Co-rods (D=20 mm).



**Figure 9.** Axial distributions at EOL (630 irradiation days) of the  $^{235}\text{U}$  burn-up (left) and fission density (right) in 4 transverse regions of the exterior plate for the scenario of DDE-MITR-FE with cobalt rods, D=20 mm as shown in Figure 8b.

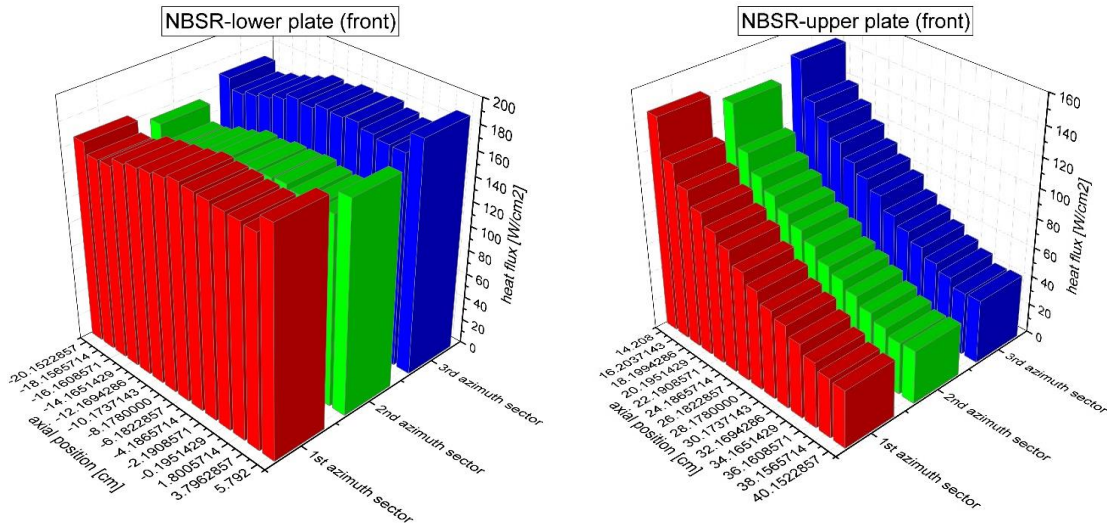


**Figure 10.** Time evolution of  $^{235}\text{U}$  burn-up (left) and fission density (right) during  $\sim 26$  BR2 operation cycles for the scenario of DDE-MITR-FE with cobalt rods as shown in Figure 8b. The different colors refer to the different axial zones in the ‘hottest’ transverse region.

## 6.2. DDE-NBSR-FE

### 6.2.1. Heat flux distribution

The distributions of the heat flux in the three azimuthal regions of the exterior front plate in each upper and lower plate are shown in Figure 11. The maximum heat flux in the hottest spot is slightly higher than the requested ( $180 \text{ W/cm}^2$  vs.  $160 \text{ W/cm}^2$ ), however this can be easily corrected by modifying the irradiation conditions in the surrounding channels.

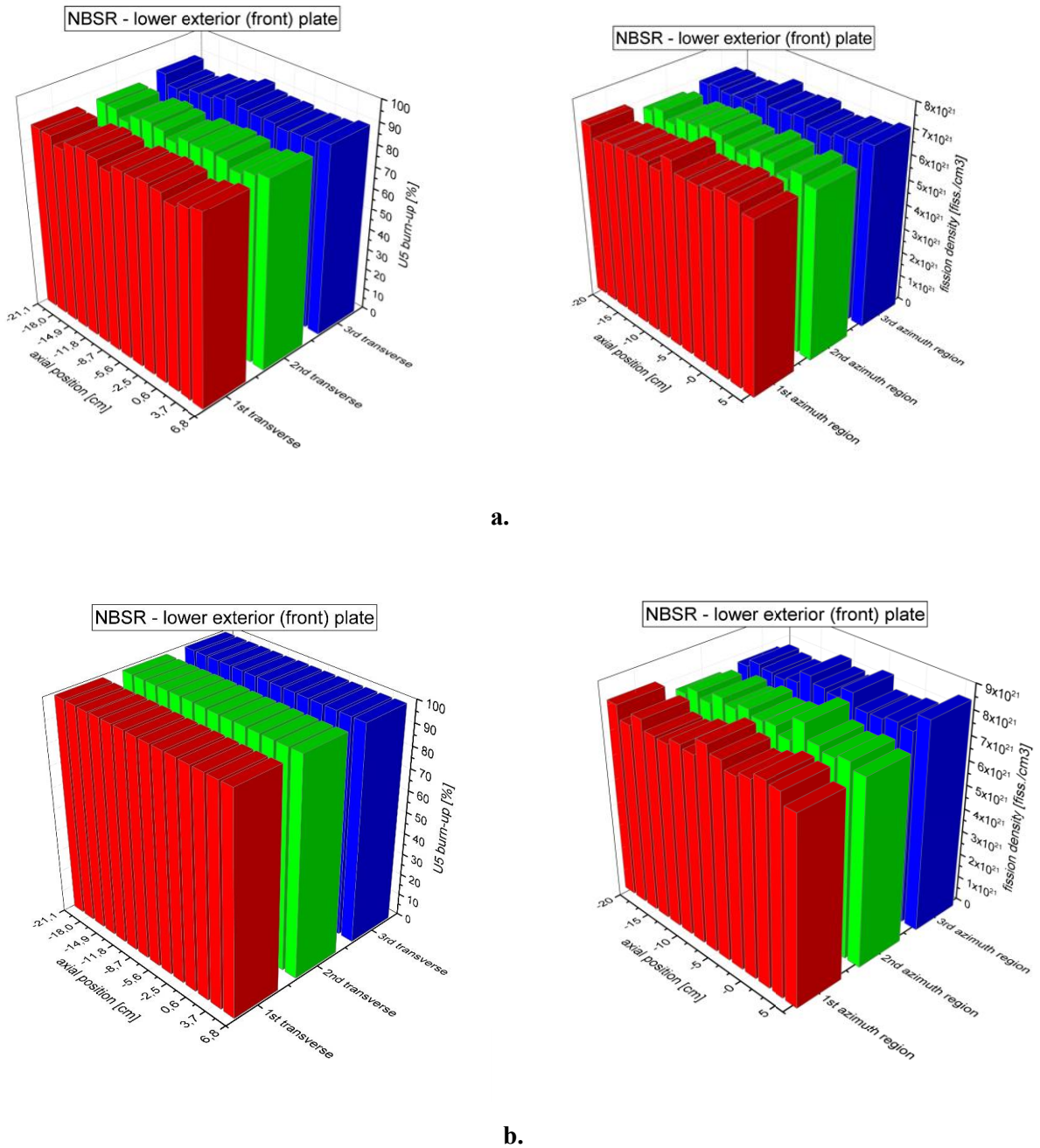


**Figure 11.** Heat flux distributions at BOL in the axial meshes of the exterior DDE-NBSR-FE lower plate (left) and upper plate (right).

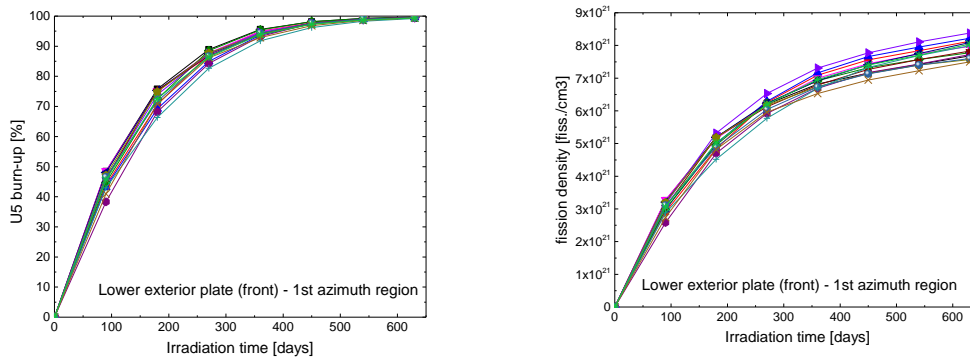
### 6.2.2. Burn-up and fuel density distributions

Axial distributions of the  $^{235}\text{U}$  burn-up (in %) and fission density ( $\text{fiss./cm}^3$ ) have been calculated in the spatial meshes of the upper and lower plates of the DDE-NBSR-FE. The calculations have been followed as for the DDE-MITR-FE during 26 consecutive BR2 operation cycles. The distributions of the  $^{235}\text{U}$  burn-up and fission density after 350 and after 630 irradiation days in the exterior lower plate are shown in Figure 12a and Figure 12b, respectively. The time evolutions of the  $^{235}\text{U}$  burn-up and fission density in the lower

plate are given in Figure 13. It is interesting to see that these time evolutions are not linear and after about 350 irradiation days the distributions almost saturate.



**Figure 12.** Axial distributions of  $^{235}\text{U}$  burn-up (left) and fission density (right) in 3 azimuthal regions of the lower exterior front plate of DDE-NBSR-FE: **a.** after 350 irradiation days ; **b.** after 630 irradiation days.



**Figure 13.** Time evolution of  $^{235}\text{U}$  burn-up (left) and fission density (right) in the axial meshes of each azimuthal region in the *lower* plate of the DDE-NBSR-FE in the channel H3.

## 7. CONCLUSIONS

The simultaneous irradiation of the DDE-MITR-FE and the DDE-NBSR-FE presents a challenge for the reactor core load management since it is necessary to find a compromise solution for satisfying two opposite target irradiation conditions, such as very low maximum heat flux ( $Q_{\max} \sim 64 \text{ W/cm}^2$  in DDE-MITR-FE) and almost 3 times higher maximum heat flux ( $Q_{\max} \sim 160 \text{ W/cm}^2$  in DDE-NBSR-FE). In conclusion, we have shown that the BR2 reactor is able to perform simultaneous irradiation of both DDE's and reach the requested irradiation targets (maximum heat flux, maximum fission density) at the conditions of the original reactors. The requested maximum fission density of  $5.8\text{E}21 \text{ fiss./cm}^3$  in the DDE-MITR-FE is achieved after about 26 BR2 cycles at 90%  $^{235}\text{U}$  burn-up. The fission density in the DDE-NBSR-FE almost saturates after 15 cycles at  $6.5\text{E}21 \text{ fiss./cm}^3$  and 90%  $^{235}\text{U}$  burn-up. The maximum theoretical fission density due to  $^{235}\text{U}$  fission is  $6.6\text{E}21 \text{ fiss./cm}^3$ . The additional contribution from all actinides evaluated with MCNP6 can be up to  $\sim 20\%$ . Therefore, it is concluded that the irradiation of the DDE-NBSR-FE during  $\sim 15$  BR2 irradiation cycles would be sufficient to achieve the maximum possible fission density. On the other hand, the flexibility of the BR2 core loadings allow not only to 'copy' the conditions of another reactor, but also to accelerate the qualification of the new LEU fuel by optimizing the irradiation campaign and the DDE's surrounding irradiation conditions.

## NOMENCLATURE

BOL – Beginning Of Life  
 BR2 – Belgian Reactor 2  
 DG – device for isotope production  
 DDE-MITR-FE – Design Demonstration Element of the MITR  
 DDE-NBSR-FE – Design Demonstration Element of the NBSR  
 EOL – End Of Life  
 FE – Fuel Element  
 H1, H2, H3, H4, H5 – BR2 reactor beryllium channels ( $D=200 \text{ mm}$ )  
 H1/C – Central channel ( $D=84 \text{ mm}$ ) in H1 channel  
 HEU – High Enriched Uranium  
 LEU – Low Enriched Uranium  
 LTA – Lead Test Assembly  
 MITR – Massachusetts Institute of Technology Reactor  
 NBSR – National Bureau of Standards Reactor

$Q_{\max}$  – maximum heat flux [ $\text{W}/\text{cm}^2$ ]

$F_{\max}$  – maximum fission density [fissions/ $\text{cm}^3$ ]

RA-basket – used to load capsules for irradiation in BR2 beryllium channel

SCK•CEN – Belgian Nuclear Research Center

## REFERENCES

1. MCNP6.1.1beta, LA-CP-14-00745, Rev. 0, 14 June 2014.
2. S. Kalcheva, G. Van den Branden, “Preparatory Studies for Qualification of Lead Test Assemblies with Gadolinium as Burnable Absorber in the BR2 Reactor,” *M&C 2017*, Jeju, Korea, April 16-20, 2017.
3. S. Kalcheva, G. Van den Branden, V. Kuzminov, E. Koonen, “Reactor Core Simulations for Determination of the Antineutrino Spectrum for the SoLid Experiment at BR2 Reactor,” *M&C 2017*, Jeju, Korea, April 16-20, 2017.